

# *TUR012-P / F0..-P*

*FLOWRATE INDICATOR / TOTALIZER*

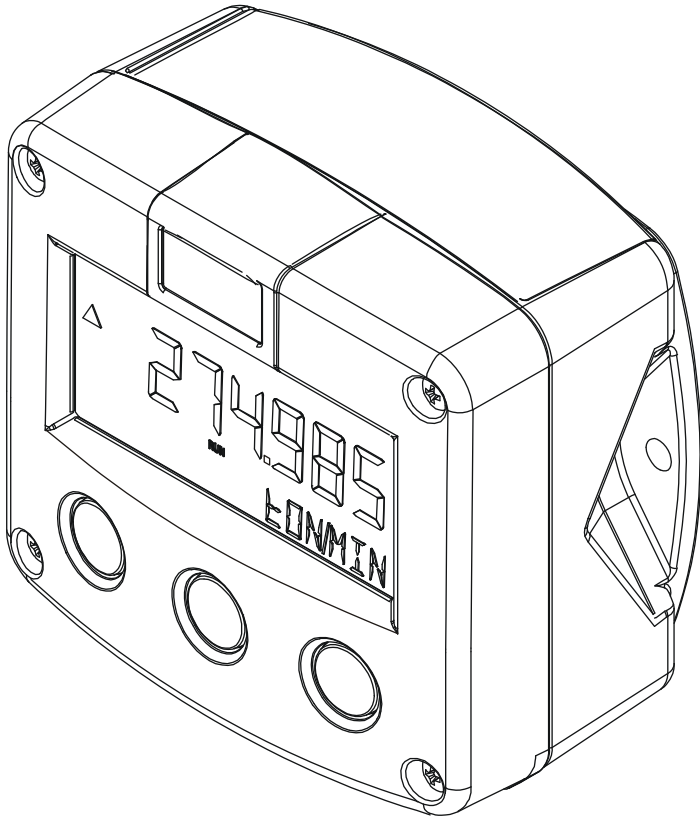

*Signal input flowmeter: coil.*

*Options: Intrinsically Safe.*



## SAFETY INSTRUCTIONS



- *Any responsibility is lapsed if the instructions and procedures as described in this manual are not followed.*



- *LIFE SUPPORT APPLICATIONS: The TUR012-P is not designed for use in life support appliances, devices, or systems where malfunction of the product can reasonably be expected to result in a personal injury. Customers using or selling these products for use in such applications do so at their own risk and agree to fully indemnify the manufacturer and supplier for any damages resulting from such improper use or sale.*



- *Electro static discharge does inflict irreparable damage to electronics! Before installing or opening the unit, the installer has to discharge himself by touching a well-grounded object.*



- *This unit must be installed in accordance with the EMC guidelines (Electro Magnetic Compatibility).*



- *Intrinsically Safe applications: follow the instructions as mentioned in Chapter 4 and consult "Turbines Inc. TUR0121-P-XI - Documentation for Intrinsic Safety / Fluidwell F0-Series indicator model F0.-P-XI".*

## SAFETY RULES AND PRECAUTIONARY MEASURES

- The manufacturer accepts no responsibility whatsoever if the following safety rules and precautions instructions and the procedures as described in this manual are not followed.
- Modifications of the TUR012-P implemented without preceding written consent from the manufacturer, will result in the immediate termination of product liability and warranty period.
- Installation, use, maintenance and servicing of this equipment must be carried out by authorized technicians.
- Check the mains voltage and information on the manufacturer's plate before installing the unit.
- Check all connections, settings and technical specifications of the various peripheral devices with the TUR012-P supplied.
- Open the casing only if all leads are free of potential.
- Never touch the electronic components (ESD sensitivity).
- Never expose the system to heavier conditions than allowed according to the casing classification (see manufacture's plate and chapter 4.2.).
- If the operator detects errors or dangers, or disagrees with the safety precautions taken, then inform the owner or principal responsible.
- The local labor and safety laws and regulations must be adhered to.

## ABOUT THE OPERATION MANUAL

This operation manual is divided into two main sections:

- The daily use of the unit is described in chapter 2 "Operation". These instructions are meant for users.
- The following chapters and appendices are exclusively meant for electricians/technicians. These provide a detailed description of all software settings and hardware installation guidance.

This operation manual describes the standard unit as well as most of the options available. For additional information, please contact your supplier.

**A hazardous situation may occur if the TUR012-P is not used for the purpose it was designed for or is used incorrectly. Please carefully note the information in this operating manual indicated by the pictograms:**



A "**warning**" indicates actions or procedures which, if not performed correctly, may lead to personal injury, a safety hazard or damage of the TUR012-P or connected instruments.



Caution !

A "**caution**" indicates actions or procedures which, if not performed correctly, may lead to personal injury or incorrect functioning of the TUR012-P or connected instruments.



Note !

A "**note**" indicates actions or procedures which, if not performed correctly, may indirectly affect operation or may lead to an instrument response which is not planned.

Hardware version	:	FB03.03.xx
Software version	:	03.02.xx
Manual	:	HTUR0121PEN_v0402_02 Atex_IECEEx_CSA_FM.doc
© Copyright 2009	:	Fluidwell bv - The Netherlands.

**Information in this manual is subject to change without prior notice. The manufacturer is not responsible for mistakes in this material or for incidental damage caused as a direct or indirect result of the delivery, performance or use of this material.**

**© All rights reserved. No parts of this publication may be reproduced or used in any form or by any means without written permission of your supplier.**

# CONTENTS MANUAL

Safety instructions .....	2
Safety rules and precautionary measures .....	2
About the operation manual .....	3
Contents manual.....	4
1. Introduction .....	5
1.1. System description of the TUR012-P .....	5
2. Operational.....	6
2.1. General .....	6
2.2. Control panel.....	6
2.3. Operator information and functions .....	7
3. Configuration.....	8
3.1. Introduction .....	8
3.2. Programming SETUP-level.....	8
3.2.1. General .....	8
3.2.2. Overview functions SETUP level .....	11
3.2.3. Explanation of SETUP-functions.....	12
1 - Total.....	12
2 - Flowrate .....	13
3 - Display .....	14
4 - Power management .....	14
5 - Flowmeter .....	15
6 - Others .....	15
4. Installation .....	16
4.1. General directions .....	16
4.2. Installation / surrounding conditions .....	16
4.3. Dimensions- Enclosures .....	17
4.4. Installing the hardware.....	17
4.4.1. Introduction .....	17
4.4.2. Intrinsically safe applications .....	18
4.4.2.1. General information and instructions: .....	18
4.4.2.2. Terminal connectors with power supply - type : PC / PX.....	19
4.4.2.3. Configuration examples Intrinsically Safe applications:.....	21
4.4.2.4. Battery replacement instructions.....	22
5. Maintenance.....	23
5.1. General directions .....	23
5.2. Repair.....	23
Appendix A: Technical specification .....	24
Appendix B: Problem solving.....	26
Index of this manual.....	27
List of figures in this manual .....	27
List of configuration settings .....	28

## 1. INTRODUCTION

### 1.1. SYSTEM DESCRIPTION OF THE TUR012-P

#### Functions and features

The flowrate / totalizer model TUR012-P is a microprocessor driven instrument designed to display flowrate, total and accumulated total.

This product has been designed with a focus on:

- ultra-low power consumption to allow long-life battery powered applications (type PB / PC),
- intrinsic safety for use in hazardous applications (type XI),
- several mounting possibilities with GRP or aluminum enclosures for industrial surroundings,
- ability to process all types of flowmeter signals,

#### Flowmeter input

This manual describes the unit with a pulse type input from the flowmeter "-P version".

One flowmeter with a sine wave (coil) signal output can be connected to the TUR012-P. The unit is battery powered (type PC) but can also be externally powered with 8-30V DC (type PX).

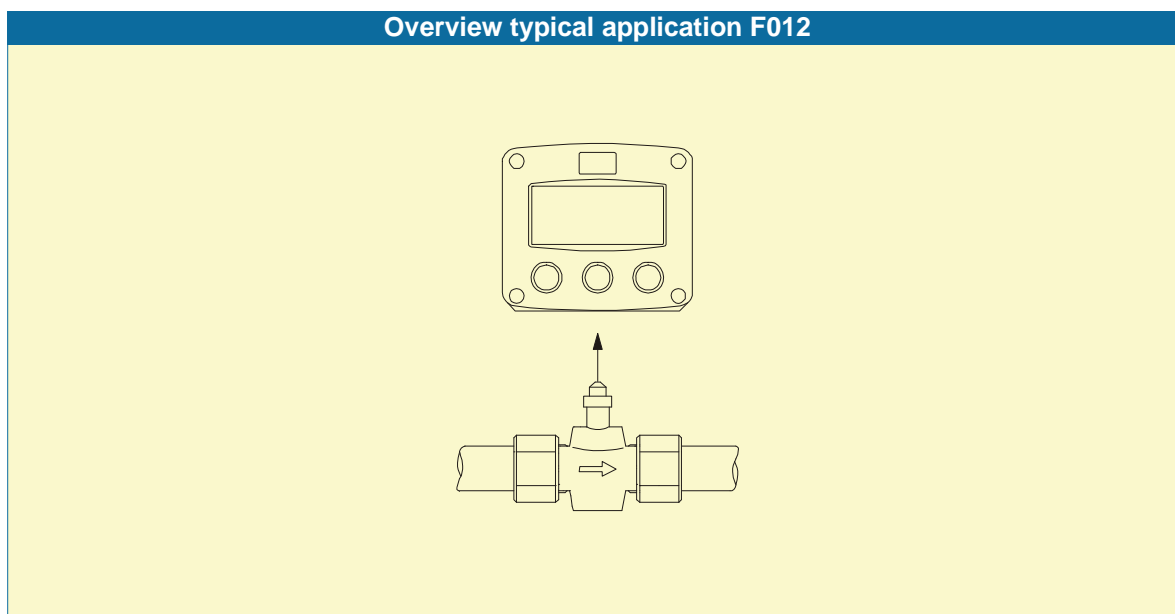

*Fig. 1: Typical application for the TUR012-P.*

#### Configuration of the unit

The TUR012-P has been designed to be implemented in many types of applications. For that reason, a SETUP-level is available to configure your TUR012-P according to your specific requirements.

It includes several important features, such as K-factors, measurement units, signal selection etc. All settings are stored in EEPROM memory and will not be lost in the event of power failure. To extend the battery-life time, please use of the power-management functions as described in chapter 3.2.3.

#### Display information

The unit has a large transfective LCD with all kinds of symbols and digits to display measuring units, status information, trend-indication and key-word messages.

Flowrate and totals can be displayed either with the small 8mm digits or with the 17mm digits.

A backup of the total and accumulated total in EEPROM memory is made every minute.

#### Options

The following options are available: intrinsic safety, power- and sensor-supply options, panel-mount, wall-mount and weather-proof enclosures, flame proof enclosure and LED backlight.

## 2. OPERATIONAL

### 2.1. GENERAL



- *The TUR012-P may only be operated by personnel who are authorized and trained by the operator of the facility. All instructions in this manual are to be observed.*
- *Take careful notice of the " Safety rules, instructions and precautionary measures " in the front of this manual.*

This chapter describes the daily use of the TUR012-P. This instruction is meant for users / operators.

### 2.2. CONTROL PANEL

The following keys are available:

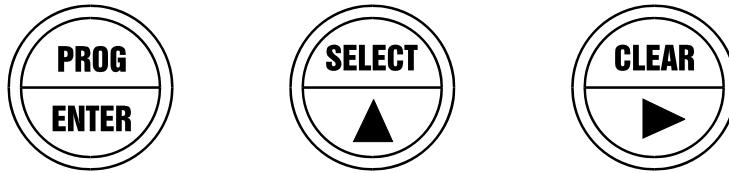

Fig. 2: Control Panel.

#### Functions of the keys



This key is used to program and save new values or settings.  
It is also used to gain access to SETUP-level; please read chapter 3.



This key is used to SELECT accumulated total.  
The arrow-key ▲ is used to increase a value after PROG has been pressed or to configure the unit; please read chapter 3.



Press this key twice to CLEAR the value for total.  
The arrow-key ► is used to select a digit after PROG has been pressed or to configure the unit; please read chapter 3.

### 2.3. OPERATOR INFORMATION AND FUNCTIONS

In general, the TUR012-P will always function at Operator level. The information displayed is dependant upon the SETUP-settings. The signal from the connected sensor is processed by the TUR012-P in the background, whichever screen refresh rate setting is chosen. After pressing a key, the display will be updated very quickly during a 30 second period, after which it will slow-down again.



Fig. 3: Example of display information during process.

For the Operator, the following functions are available:

- **Display flowrate / total or flowrate**  
This is the main display information of the TUR012-P. After selecting any other information, it will always return to this main display automatically.  
Total is displayed on the upper-line of the display and flowrate on the bottom line.  
It is possible to display flowrate only with the large 17mm digits; in this instance press the SELECT-key to read the total.  
When "-----" is shown, then the flowrate value is too high to be displayed. The arrows  $\blacktriangleleft$   $\blacktriangleright$  indicate the increase/decrease of the flowrate trend.
- **Clear total**  
The value for total can be re-initialized. To do so, press CLEAR twice. After pressing CLEAR once, the flashing text "PUSH CLEAR" is displayed. To avoid re-initialization at this stage, press another key than CLEAR or wait for 20 seconds.  
Re-initialization of total DOES NOT influence the accumulated total.
- **Display accumulated total**  
When the SELECT-key is pressed, total and accumulated total are displayed. The accumulated total cannot be re-initialized. The value will count up to 99,999,999,999. The unit and number of decimals are displayed according to the configuration settings for total.
- **Low-battery alarm**  
When the battery voltage drops, it must be replaced. At first "low-battery" will flash, but as soon as it is displayed continuously, the battery MUST be replaced shortly after!  
Only original batteries supplied by the manufacturer may be used, else the guarantee and liability will be terminated. The remaining lifetime after the first moment of indication is generally several days up to some weeks.



Fig. 4: Example of low-battery alarm.

Alarm 01-03 When "alarm" is displayed, please consult Appendix B: problem solving.

### 3. CONFIGURATION

#### 3.1. INTRODUCTION

This and the following chapters are exclusively meant for electricians and non-operators. In these, an extensive description of all software settings and hardware connections are provided.



- *Mounting, electrical installation, start-up and maintenance of the instrument may only be carried out by trained personnel authorized by the operator of the facility. Personnel must read and understand this Operating Manual before carrying out its instructions.*
- *The TUR012-P may only be operated by personnel who are authorized and trained by the operator of the facility. All instructions in this manual are to be observed.*
- *Ensure that the measuring system is correctly wired up according to the wiring diagrams. The housing may only be opened by trained personnel.*
- *Take careful notice of the " Safety rules, instructions and precautionary measures " in the front of this manual.*

#### 3.2. PROGRAMMING SETUP-LEVEL

##### 3.2.1. GENERAL

Configuration of the TUR012-P is done at SETUP-level. SETUP-level is reached by pressing the PROG/ENTER key for 7 seconds; at which time, both arrows  $\blacktriangle$  will be displayed. In order to return to the operator level, PROG will have to be pressed for three seconds. Alternatively, if no keys are pressed for 2 minutes, the unit will exit SETUP automatically. SETUP can be reached at all times while the TUR012-P remains fully operational.



**Note:** A pass code may be required to enter SETUP. Without this pass code access to SETUP is denied.

To enter SETUP-level:

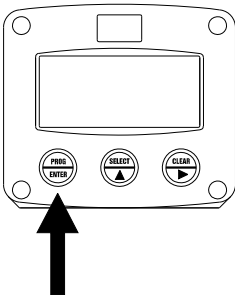

Press  for 7 seconds



**Matrix structure SETUP-level:**

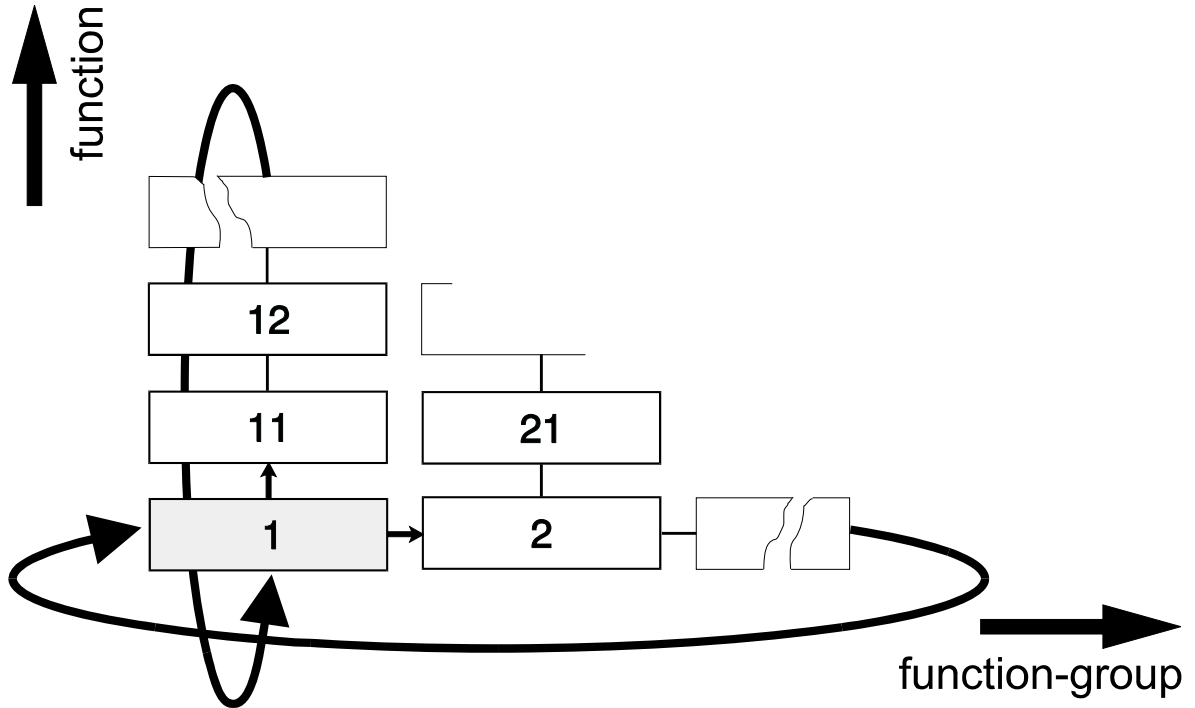

**SCROLLING THROUGH SETUP-LEVEL**

**Selection of function-group and function:**

SETUP is divided into several function groups and functions.

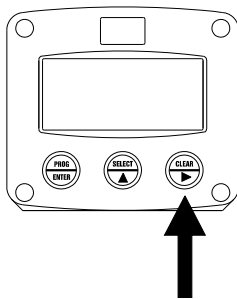

Select function-group with 

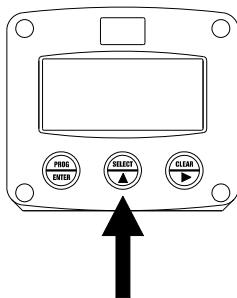





Select function with 



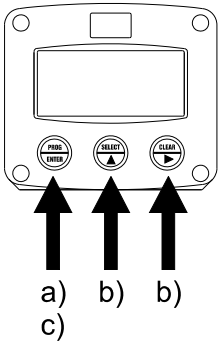

Each function has a unique number, which is displayed below the word "SETUP" at the bottom of the display. The number is a combination of two figures. The first figure indicates the function-group and the second figure the sub-function. Additionally, each function is expressed with a keyword.



After selecting a sub-function, the next main function is selected by scrolling through all "active" sub-functions (e.g. 1<sup>▲</sup>, 11<sup>▲</sup>, 12<sup>▲</sup>, 13<sup>▲</sup>, 14<sup>▲</sup>, 1<sup>▶</sup>, 2<sup>▶</sup>, 3<sup>▲</sup>, 31 etc.). The "CLEAR" button can be used to jump a step back if you missed the desired function.

To change or select a value:



- a) press  briefly; **PROGRAM** will start flash
- b) select or enter value with  and / or 
- c) press  to confirm the value / selection.

To change a value, use  to select the digits and  to increase that value. If the new value is invalid, the increase sign  or decrease-sign  will be displayed while you are programming.

To select a setting,  is used to select in one direction and  can be used to select in the other direction.

When data is altered but ENTER is not pressed, then the alteration can still be cancelled by waiting for 20 seconds or by pressing ENTER for three seconds: the PROG-procedure will be left automatically and the former value reinstated.



**Note:** alterations will only be set after ENTER has been pressed!

To return to OPERATOR-level:

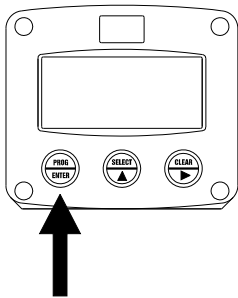

Press  for 3 seconds

In order to return to the operator level, PROG will have to be pressed for three seconds. Also, when no keys are pressed for 2 minutes, SETUP will be left automatically.

## 3.2.2. OVERVIEW FUNCTIONS SETUP LEVEL

<b>SETUP FUNCTIONS AND VARIABLES</b>			
<b>1</b>	<b>TOTAL</b>		
	11	UNIT	L - m3 - kg - lb - GAL - USGAL - bbl - no unit
	12	DECIMALS	0 - 1 - 2 - 3 (Ref: displayed value)
	13	K-FACTOR:	0.000010 - 9,999,999
	14	DECIMALS K-FACTOR	0 - 6
<b>2</b>	<b>FLOWRATE</b>		
	21	UNIT	mL - L - m3 - mg - g - kg - ton - GAL - bbl - lb - cf - REV - no unit - scf - Nm3 - NL - P
	22	TIME UNIT	sec - min - hour - day
	23	DECIMALS	0 - 1 - 2 - 3 (Ref: displayed value)
	24	K-FACTOR	0.000010 - 9,999,999
	25	DECIMALS K-FACTOR	0 - 6
	26	CALCULATION	per 1 - 255 pulses
	27	CUT-OFF	0.1 - 999.9 seconds
<b>3</b>	<b>DISPLAY</b>		
	31	FUNCTION	total - flowrate
	32	BACKLIGHT (optional)	off - green - amber
	33	BL. BRIGHTNESS	1 - 5
<b>4</b>	<b>POWER MANAGEMENT</b>		
	41	LCD UPDATE	fast - 1 sec - 3 sec - 15 sec - 30 sec - off
	42	BATTERY MODE	operational - shelf
<b>5</b>	<b>FLOWMETER</b>		
	51	SIGNAL	coil_hi - coil_lo
<b>6</b>	<b>OTHERS</b>		
	61	MODEL	F0-P
	62	TYPE	TUR0121-P
	63	SOFTWARE VERSION	03.xx.xx
	64	SERIAL NO.	xxxxxxx
	65	PASS CODE	0000 - 9999
	66	TAGNUMBER	0000000 - 9999999

## 3.2.3. EXPLANATION OF SETUP-FUNCTIONS

1 - TOTAL	
<b>MEASUREMENT UNIT 11</b>	<p>SETUP - 11 determines the measurement unit for total and accumulated total. The following units can be selected:</p> <p style="text-align: center;">L - m3 - kg - lb. - GAL - USGAL - bbl - _ (no unit).</p> <p>Alteration of the measurement unit will have consequences for operator and SETUP-level values. Please note that the K-factor has to be adapted as well; the calculation is not done automatically.</p>
<b>DECIMALS 12</b>	<p>The decimal point determines for total and accumulated total the number of digits following the decimal point. The following can be selected:</p> <p style="text-align: center;">000000 - 111111.1 - 22222.22 - 3333.333</p>
<b>K-FACTOR 13</b>	<p>With the K-factor, the flowmeter pulse signals are converted to a quantity. The K-factor is based on the number of pulses generated by the flowmeter per selected measurement unit (SETUP 11), for example per cubic meter. The more accurate the K-factor, the more accurate the functioning of the system will be.</p> <p><b>Example 1: Calculating the K-factor.</b> <i>Let us assume that the flowmeter generates 2.4813 pulses per liter and the selected unit is "cubic meters / m3". A cubic meter consists of 1000 parts of one liter which implies 2,481.3 pulses per m3. So, the K-factor is 2,481.3. Enter for SETUP - 13: "2481300" and for SETUP - 14 - decimals K-factor "3".</i></p> <p><b>Example 2: Calculating the K-factor.</b> <i>Let us assume that the flowmeter generates 6.5231 pulses per gallon and the selected measurement unit is gallons. So, the K-Factor is 6.5231. Enter for SETUP - 13: "6523100" and for SETUP - 14 decimals K-factor "6".</i></p>
<b>DECIMALS K-FACTOR 14</b>	<p>This setting determines the number of decimals for the K-factor entered. (SETUP 13). The following can be selected:</p> <p style="text-align: center;">0 - 1 - 2 - 3 - 4 - 5 - 6</p> <p>Please note that this setting influences the accuracy of the K-factor indirectly. (i.e. the position of the decimal point and thus the value given) This setting has NO influence on the displayed number of digits for total (SETUP 12)!</p>

## 2 - FLOWRATE

The settings for total and flowrate are entirely separate. In this way, different units of measurement can be used for each e.g. cubic meters for total and liters for flowrate.  
The display update time for flowrate is one second or more.

<b>MEASUREMENT UNIT</b> <b>21</b>	<p>SETUP - 21 determines the measurement unit for flowrate. The following units can be selected:</p> <p style="text-align: center;">mL - L - m3 - mg - g - kg - ton - GAL - bbl - lb - cf - REV - no unit - scf - Nm3 - NL - P.</p> <p>Alteration of the measurement unit will have consequences for operator and SETUP-level values. Please note that the K-factor has to be adapted as well; the calculation is not done automatically.</p>
<b>TIME UNIT</b> <b>22</b>	The flowrate can be calculated per second (SEC), minute (MIN), hour (HR) or day (DAY).
<b>DECIMALS</b> <b>23</b>	<p>This setting determines for flowrate the number of digits following the decimal point. The following can be selected:</p> <p style="text-align: center;">00000 - 1111.1 - 2222.22 - 3333.333</p>
<b>K-FACTOR</b> <b>24</b>	With the K-factor, the flowmeter pulse signals are converted to a flowrate. The K-factor is based on the number of pulses generated by the flowmeter per selected measurement unit (SETUP 21), for example per liter. The more accurate the K-factor, the more accurate the functioning of the system will be. For examples read SETUP 13.
<b>DECIMALS K-FACTOR</b> <b>25</b>	<p>This setting determines the number of decimals for the K-factor (SETUP 24). The following can be selected:</p> <p style="text-align: center;">0 - 1 - 2 - 3 - 4 - 5 - 6</p> <p>Please note that this SETUP - influences the accuracy of the K-factor indirectly. This setting has NO influence on the displayed number of digits for "flowrate" (SETUP 23)!</p>
<b>CALCULATION</b> <b>26</b>	<p>The flowrate is calculated by measuring the time between a number of pulses, for example 10 pulses. The more pulses the more accurate the flowrate will be. The maximum value is 255 pulses.</p> <p><b>Note:</b> <i>the lower the number of pulses, the higher the power consumption of the unit will be (important for battery powered applications).</i></p> <p><b>Note:</b> <i>for low frequency applications (below 10Hz): do not program more than 10 pulses else the update time will be very slow.</i></p> <p><b>Note:</b> <i>for high frequency application (above 1kHz) do program a value of 100 or more pulses.</i></p>
<b>CUT-OFF TIME</b> <b>27</b>	<p>With this setting, you determine a minimum flow requirement threshold, if during this time less than XXX-pulses (SETUP 26) are generated, the flowrate will be displayed as zero.</p> <p>The cut-off time has to be entered in seconds - maximum time is 999 seconds (about 15 minutes).</p>



Note !

3 - DISPLAY	
<b>FUNCTION</b> 31	The large 17mm digits can be set to display total or flowrate. When "total" is selected, both total and flowrate are displayed simultaneously. When "flowrate" is selected, only flowrate will be displayed with it's measuring unit while total will be displayed after pressing SELECT.
The functions below will only effect the optional LED-backlight.	
<b>BACKLIGHT (OPTION)</b> 32	If a LED backlight has been supplied, the color can be selected. Following selections are available:  OFF - GREEN - AMBER
<b>BRIGHTNESS (OPTION)</b> 33	The density of the backlight can be set in following range:  1 - 5  One is minimum and five is maximum brightness.

4 - POWER MANAGEMENT	
When used with the internal battery option, the user can expect reliable measurement over a long period of time. The TUR012-P has several smart power management functions to extend the battery life time significantly. Two of these functions can be set:	
<b>LCD NEW</b> 41	The calculation of the display-information influences the power consumption significantly. When the application does not require a fast display update, it is <b>strongly advised</b> to select a slow refresh rate. Please understand that NO information will be lost; every pulse will be counted and the output signal will be generated in the normal way. The following can be selected:  Fast - 1 sec - 3 sec - 15 sec - 30 sec - off.  <b>Example battery life-time:</b> <i>life-time with a coil pick-up, 1kHz. pulses and FAST update: about 2 years.</i> <i>life-time with a coil pick-up, 1kHz. pulses and 1 sec update: about 5 years.</i>  <b>Note:</b> after a button has been pressed by the operator - the display refresh rate will always switch to FAST for 30 seconds. When "OFF" is selected, the display will be switched off after 30 seconds and will be switched on as soon as a button has been pressed.
<b>BATTERY-MODE</b> 42	The unit has two modes: operational or shelf. After "shelf" has been selected, the unit can be stored for several years; it will not process the sensor signal; the display is switched off but all settings and totals are stored. In this mode, power consumption is extremely low. To wake up the unit again, press the SELECT-key twice.



Note !

## 5 - FLOWMETER

<b>SIGNAL 51</b>	The TUR0121-P is able to handle sine wave (coil) types of input signal. The sensitivity of flowmeter pickup is selected with SETUP 51. Read also par. 4.4.2. or 4.4.3 - flowmeter input terminals.			
TYPE OF SIGNAL	EXPLANATION	RESISTANCE	FREQ. / MV	REMARK
COIL HI	High sensitive coil input	-	20mV p.t.p.	Sensitive for disturbance!
COIL LO	Low sensitive coil input	-	90mV p.t.p.	Normal sensitivity

## 6 - OTHERS

<b>MODEL 61</b>	For support and maintenance it is important to have information about the characteristics of the TUR0121-P. The main platform of this product is the F0-series with pulse input signal - type P. Your supplier will ask for this information in the case of a serious breakdown or to assess the suitability of your model for upgrade considerations.
<b>TYPE 62</b>	For support and maintenance it is important to have information about the characteristics of the TUR0121-P. This window offers you the product specific information: TUR0121-P. Your supplier will ask for this information in the case of a serious breakdown or to assess the suitability of your model for upgrade considerations.
<b>VERSION SOFTWARE 63</b>	For support and maintenance it is important to have information about the characteristics of the TUR0121-P. Your supplier will ask for this information in the case of a serious breakdown or to assess the suitability of your model for upgrade considerations.
<b>SERIAL NUMBER 64</b>	For support and maintenance it is important to have information about the characteristics of the TUR0121-P. Your supplier will ask for this information in the case of a serious breakdown or to assess the suitability of your model for upgrade considerations.
<b>PASS CODE 65</b>	All SETUP-values can be pass code protected. This protection is disabled with value 0000 (zero). Up to and including 4 digits can be programmed, for example 1234.
<b>TAGNUMBER 66</b>	For identification of the unit and communication purposes, a unique tag number of maximum 7 digits can be entered.

## 4. INSTALLATION

### 4.1. GENERAL DIRECTIONS



- *Mounting, electrical installation, start-up and maintenance of this instrument may only be carried out by trained personnel authorized by the operator of the facility. Personnel must read and understand this Operating Manual before carrying out its instructions.*
- *The TUR0121-P may only be operated by personnel who are authorized and trained by the operator of the facility. All instructions in this manual are to be observed.*
- *Ensure that the measuring system is correctly wired up according to the wiring diagrams. Protection against accidental contact is no longer assured when the housing cover is removed or the panel cabinet has been opened (danger from electrical shock). The housing may only be opened by trained personnel.*
- *Take careful notice of the " Safety rules, instructions and precautionary measures " at the front of this manual.*

### 4.2. INSTALLATION / SURROUNDING CONDITIONS

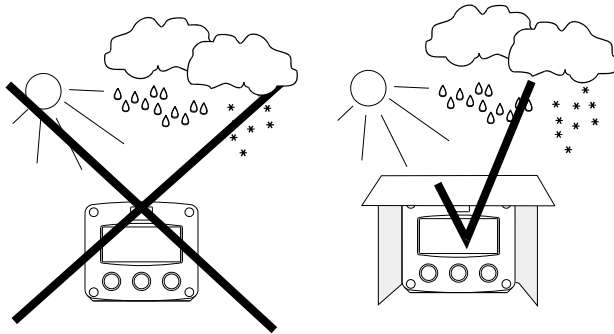

Take the relevant IP classification of the casing into account (see manufactures plate). Even an IP67 (NEMA 4X) casing should NEVER be exposed to strongly varying (weather) conditions.

When panel-mounted, the unit is IP65 (NEMA 4)!

When used in very cold surroundings or varying climatic conditions, take the necessary precautions against moisture by placing a dry sachet of silica gel, for example, inside the instrument case.

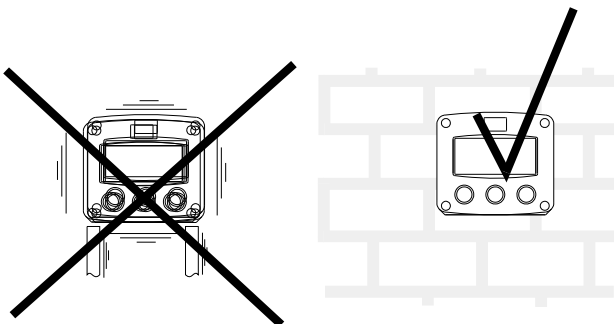

Mount the TUR0121-P on a solid structure to avoid vibrations.



### 4.3. DIMENSIONS- ENCLOSURES

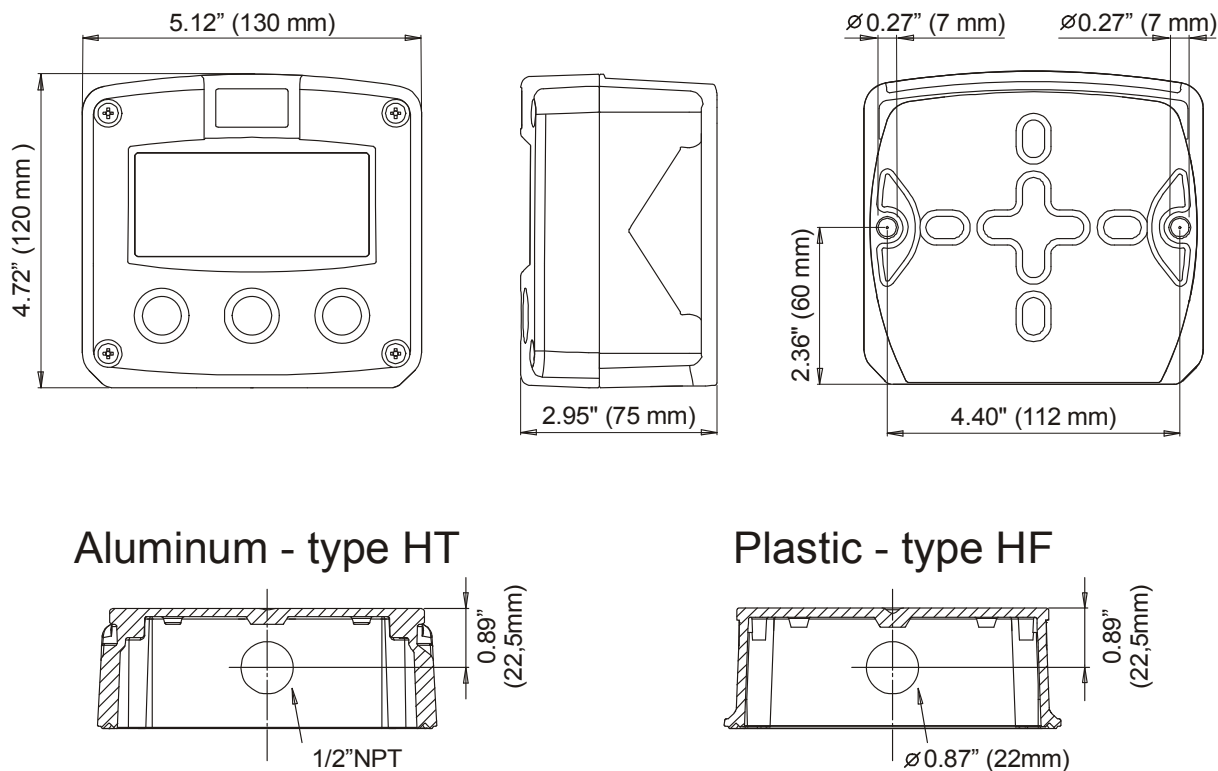

Fig. 5: Dimension enclosures.

### 4.4. INSTALLING THE HARDWARE

#### 4.4.1. INTRODUCTION



- *Electro static discharge does inflict irreparable damage to electronics! Before installing or opening the unit, the installer has to discharge himself by touching a well-grounded object.*



- *This unit must be installed in accordance with the EMC guidelines (Electro Magnetic Compatibility).*

#### FOR INSTALLATION, PAY EMPHATIC ATTENTION TO:

- Separate cable glands with effective IP67 (NEMA4X) seals for all wires.
- Unused cable entries: ensure that you fit IP67 (NEMA4X) plugs to maintain rating.
- A reliable ground connection for both the sensor, and if applicable, for the metal casing. (above)
- An effective screened cable for the input signal, and grounding of it's screen to the "⊥" terminal or at the sensor itself, whichever is appropriate to the application.

4.4.2. INTRINSICALLY SAFE APPLICATIONS

4.4.2.1. GENERAL INFORMATION AND INSTRUCTIONS:



- *Mounting, electrical installation, start-up and maintenance of this device may only be carried out by trained personnel authorized by the operator of the facility. Personnel must read and understand this Operating Manual before carrying out its instructions.*
- *This device may only be operated by personnel who are authorized and trained by the operator of the facility. All instructions in this manual are to be observed.*
- *Ensure that the measuring system is correctly wired up according to the wiring diagrams. Protection against accidental contact is no longer assured when the housing cover is removed or the cabinet has been opened (danger of electric shock). The housing may only be opened by trained personnel.*
- *Take careful notice of the " Safety rules, instructions and precautionary measures " in the front of this manual.*

*Safety Instructions*



- *Certificates, safety values, control drawing and declaration of compliance can be found in the document named: "Turbines Inc. TUR0121-P-XI - Documentation for Intrinsic Safety / Fluidwell F0-Series indicator model F0..-P-XI".*
- *For installation under ATEX directive: this intrinsically safe device must be installed in accordance with the Atex directive 94/9/EC and the product certificate KEMA 05ATEX1168 X.*
- *For installation under IECEx scheme: this intrinsically safe device must be installed in accordance the product certificate IECEx KEM 08.0006X.*
- *For installation under CSA: this intrinsically safe device must be installed in accordance the product certificate CSA.08.2059461 X.*
- *For installation under FM: this intrinsically safe device must be installed in accordance with the Certificate / Project ID: 3033306.*
- *The control drawing number FWCD-0003 can be found in the document named: "Turbines Inc. TUR0121-P-XI - Documentation for Intrinsic Safety / Fluidwell F0-Series indicator model F0..-P-XI".*
- *Exchange of Intrinsically Safe battery FWLiBAT-00x with certificate number KEMA 03ATEX1071 U or IECEx KEM 08.0005U is allowed in Hazardous Area. See paragraph 5.4. for battery replacement instructions.*

*Please note*



- *Special conditions for safe use mentioned in both the certificate and the installation instructions must be observed for the connection of power to both input and / or output circuits.*
- *When installing this device in hazardous areas, the wiring and installation must comply with the appropriate installation standards for your industry.*
- *Study the following pages with wiring diagrams per classification.*

**Serial number and year of production**

This information can be looked-up on the display: setup function (par. 3.2.2.).

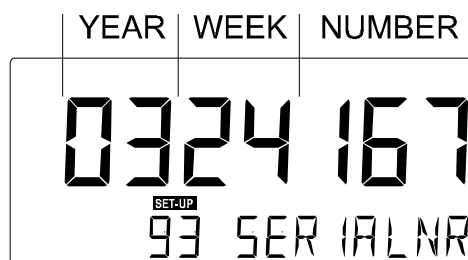

Fig. 6: Example serial number.

**Label information pulse input type - F0..P-XI (inside and outside the enclosure)**

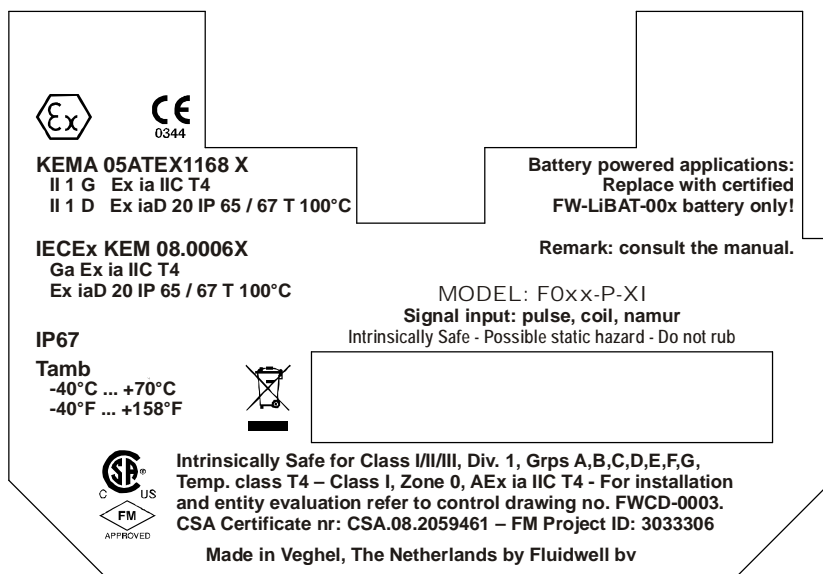
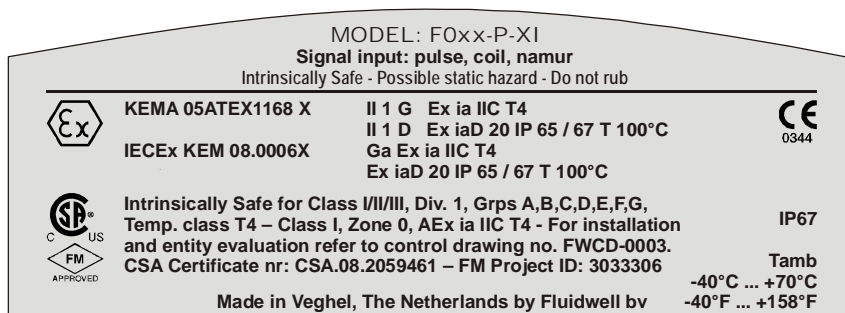

Fig. 7: Label information Intrinsically Safe application.

**4.4.2.2. TERMINAL CONNECTORS WITH POWER SUPPLY - TYPE : PC / PX**

The following terminal connectors are available:

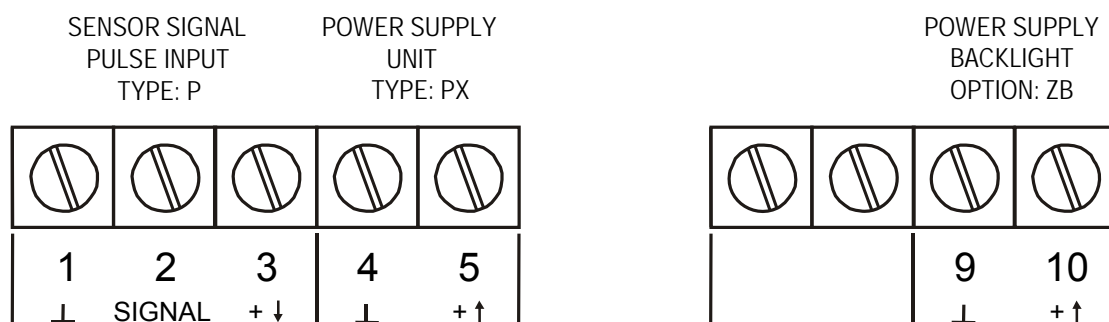

Fig. 8: Overview of terminal connectors TUR0121-P-(PC / PX) and options.

**REMARKS: TERMINAL CONNECTORS:**

**Terminals 1-3; Flowmeter input:**

**Coil-signal:**

The TUR0121-P is suitable for use with flowmeters which have a coil output signal. Two sensitivity levels can be selected with the SETUP-function:

COIL LO: sensitivity from about 90mV peak to peak.

COIL HI: sensitivity from about 20mV peak to peak.

The input signal type has to be selected with the correct SETUP-function (read par. 3.2.3.)

Option ZF offers for setting COIL HI : sensitivity from about 10mV peak to peak.

Option ZG offers for setting COIL HI : sensitivity from about 5mV peak to peak.

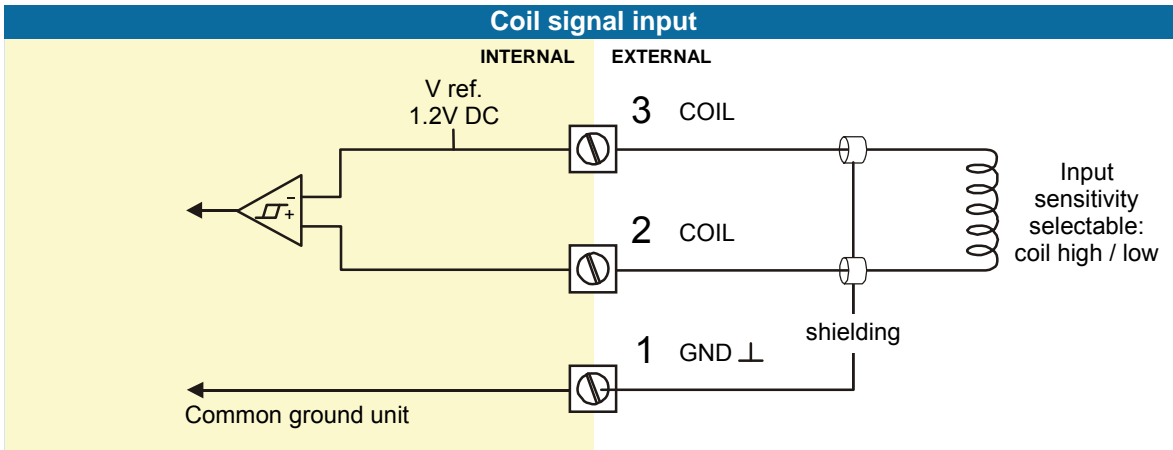

**Terminal 4-5: POWER SUPPLY UNIT - TYPE PX:**

To power the unit an internal battery can be used (type PC) and / or an external DC power supply of 8-30V DC (type PX).

Connect the "-" to terminal 4 and the "+" to terminal 5. When power is applied to these terminals, the optional internal battery will be disabled / enabled automatically to extend the battery life time.

**Remarks power supply options:**

**Type PX:** as standard, all intrinsically product are supplied with terminal 4 and 5 to power the product externally.

**Type PC:** offers - additional to type PX - an internal Intrinsically Safe lithium battery. This ATEX and IECEx certified battery (FW-LiBATT-xxx) may be changed in hazardous area.

**Terminal 9-10: power supply backlight (optional):**

To power the backlight, a voltage in the range 20-35V DC has to be connected.

Connect the "-" to terminal 9 and the "+" to terminal 10.

4.4.2.3. CONFIGURATION EXAMPLES INTRINSICALLY SAFE APPLICATIONS:

Configuration example no. 1

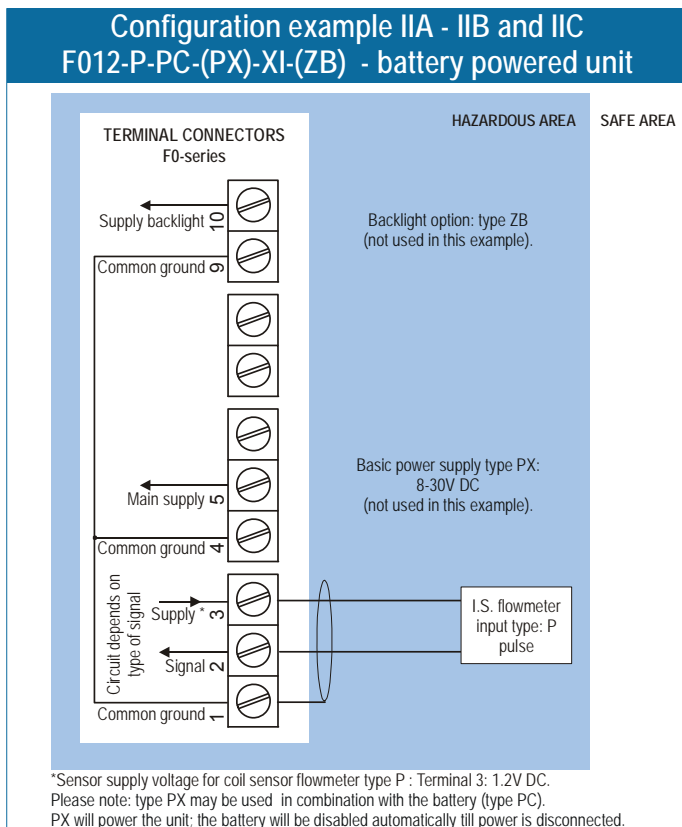

Fig. 9: Configuration example Intrinsically Safe.

Configuration example no. 2

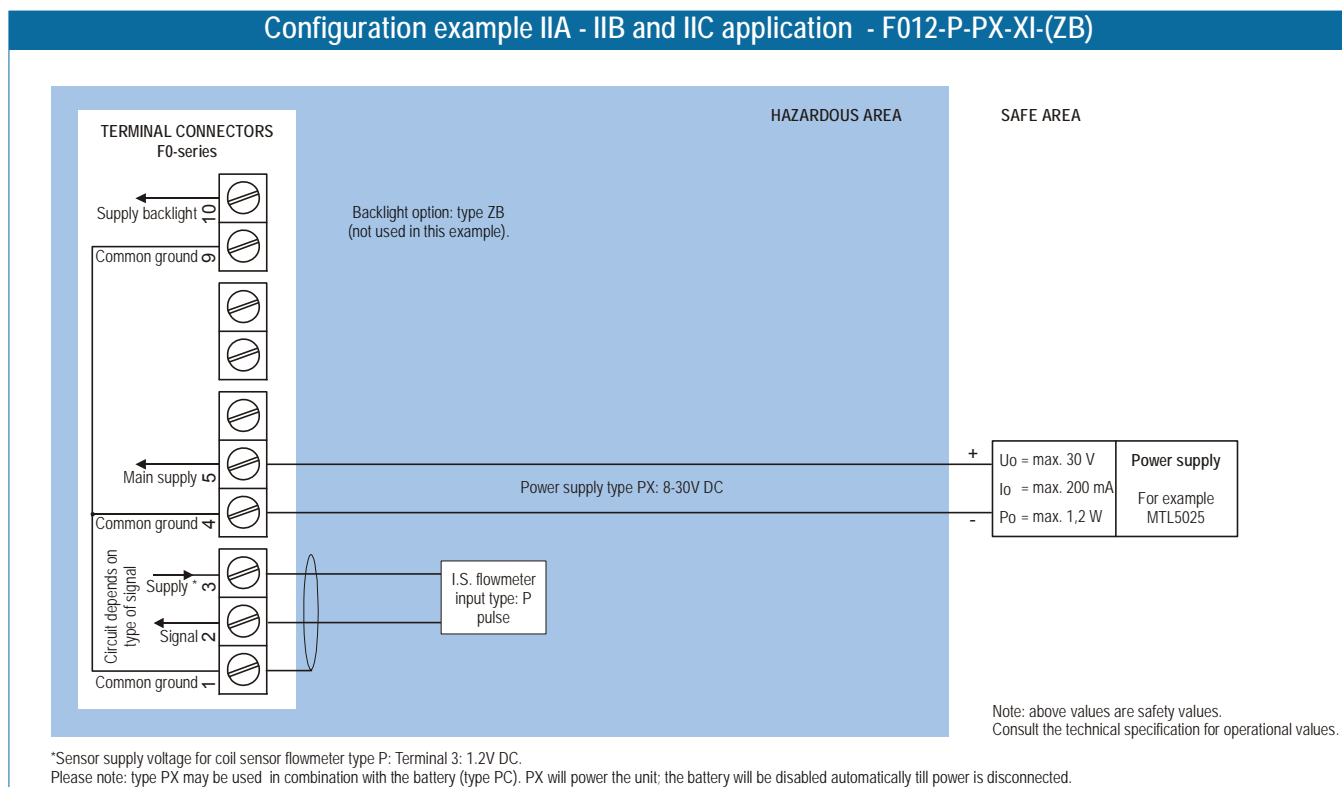

Fig. 10: Configuration example Intrinsically Safe.

4.4.2.4. BATTERY REPLACEMENT INSTRUCTIONS

# INSTRUCTION SHEET BATTERY REPLACEMENT FW-LiBAT-001

**Manufacturer**  
Fluidwell bv - The Netherlands  
www.fluidwell.com - sales@fluidwell.com

**Safety Instructions**  
**WARNING:** Fire, explosion or severe burns may result if mistreated. Do not recharge, crush, disassemble, incinerate, heat above 100°C (212°F) or expose contents to water.

**Replacement Instructions**  
Mounting, electrical installation, start-up and maintenance of this device may only be carried out by trained personnel authorized by the operator of the facility. Personnel must read and understand this Instruction before carrying out its instructions.

It is allowed to replace the Intrinsicly Safe battery FW-LiBAT-001 in hazardous area. The battery may only be replaced with an original FW-LiBAT-001 manufactured by Fluidwell bv.

For replacement, unplug the connector carefully and lift the old battery out of the mounting clip. The new battery can be placed in the clip and the connector plugged on the board.

**Disposal**  
Disposal should be done in accordance with applicable regulations, which vary from country to country. Trashing of used batteries is forbidden and disposal can be done through non-profit organizations mandated by local authorities or organized by professionals.

FW-LiBAT-001 - INST001

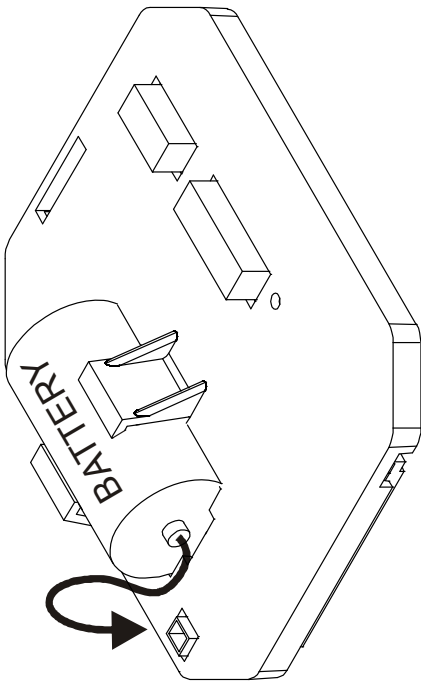

**F0-series:**

**Battery label:**

CE 0344	II 1 G Ex ia IIC Ga Ex ia IIC	KEMA 03ATEX1071 U IECEX KEM 08.0005U	Consult manual for replacement instructions. <b>WARNING:</b> Fire, explosion or severe burns may result if mistreated. Do not recharge, crush, disassemble, incinerate, heat above 100°C (212°F) or expose contents to water.
Fluidwell bv - Intrinsicly Safe Battery Part. no.: FW-LiBAT-001			
Uo = 3.9V	Co = 100µF		
Io = 35mA	Lo = 25mH		
Po = 35mW	Ta = -40°C to +70°C		
<b>Primary Lithium Battery - Only replace with Fluidwell I.S. battery pack !</b>			







Fig. 11: Battery replacement instructions Intrinsicly Safe Battery.  
HTUR0121PEN\_v0402\_02 Atex\_IECEX\_CSA\_FM.doc

## 5. MAINTENANCE

### 5.1. GENERAL DIRECTIONS



Caution !

- *Mounting, electrical installation, start-up and maintenance of the instrument may only be carried out by trained personnel authorized by the operator of the facility. Personnel must read and understand this Operating Manual before carrying out its instructions.*
- *The TUR0121-P may only be operated by personnel who are authorized and trained by the operator of the facility. All instructions in this manual are to be observed.*
- *Ensure that the measuring system is correctly wired up according to the wiring diagrams. Protection against accidental contact is no longer assured when the housing cover is removed or the panel cabinet has been opened (danger from electrical shock). The housing may only be opened by trained personnel.*
- *Take careful notice of the " Safety rules, instructions and precautionary measures " in the front of this manual.*

The TUR0121-P does not require special maintenance unless it is used in low-temperature applications or surroundings with high humidity (above 90% annual mean). It is the users responsibility to take all precautions to dehumidify the internal atmosphere of the TUR0121-P in such a way that no condensation will occur, for example by placing dry silica-gel sachet in the casing just before closing it. Furthermore, it is required to replace or dry the silica gel periodically as advised by the silica gel supplier.

#### **Battery life-time:**

It is influenced by several issues :

- Input frequency: the higher the frequency, the shorter the battery life-time.
- Flowrate calculation: the lower number of pulses (SETUP 26) the shorter the battery life-time.
- Display update: fast display update uses significantly more power.
- Low temperatures; the available power will be less due to battery chemistry.



Note !

**Note:** *It is strongly advised to use only necessary functions.*

#### **Check periodically:**

- The condition of the casing, cable glands and front panel.
- The input/output wiring for reliability and aging symptoms.
- The process accuracy. As a result of wear and tear, re-calibration of the flowmeter might be necessary. Do not forget to re-enter any subsequent K-factor alterations.
- The indication for low-battery.
- Clean the casing with soapy-water. Do not use any aggressive solvents as these might damage the polyester coating.

### 5.2. REPAIR

This product cannot be repaired by the user and must be replaced with an equivalent certified product. Repairs should only be carried out by the manufacturer or his authorized agent.

## APPENDIX A: TECHNICAL SPECIFICATION

### GENERAL

Display	
Type	High intensity reflective numeric and alphanumeric LCD, UV-resistant.
Digits	Seven 17mm (0.67") and eleven 8mm (0.31"). Various symbols and measuring units.
Refresh rate	User definable: 8 times/sec - 30 secs.
Option type ZB	Bi-color configurable LED-backlight - green or amber. Intensity adjustable from the keyboard.

Casing	
General	Polycarbonate window, silicone gasketts.
Control keys	Three industrial micro-switch keys. UV-resistant silicone keypad.
Type HT	Die-cast aluminum IP67 / NEMA 4X with 2-component UV-resistant coating.
Dimensions	5.1" x 4.72" x 2.95" (130 x 120 x 75mm) - LxHxD.
Mounting	Wall-mount, sensor head-mount, panel-mount, horizontal/vertical pipes.
Cable Entry	1x ½"NPT tapped hole in the center.
Type HF	GRP IP67 / NEMA 4X wall-mount casing, UV-resistant and V0.
Dimensions	5.1" x 4.72" x 2.95" (130 x 120 x 75mm) - LxHxD.
Cable Entry	1x 0.87" (22mm) hole in the center.

Operating temperature	
Operational	-40°F to +178°F (-40°C to +80°C).
Intrinsically Safe	-40°F to +158°F (-40°C to +70°C).

Power requirements	
Type PC	Intrinsically Safe lithium battery - life-time depends upon settings - up to 5 years.
Type PX	8-30 V DC (also available with PB / PC). Power consumption max. 0.3 Watt.
Type ZB	20-30V DC. Power consumption max. 1 Watt.
Note I.S. application	for intrinsically safe applications, consult the safety values in the certificate.

Sensor excitation	
Type PC / PX	1.2V DC for coil pick-up. Please note: this is not a real sensor supply. Only suitable for sensors like coils (sine wave).

Terminal connections	
Type:	Removable plug-in terminal strip. Wire max. 1.5mm <sup>2</sup> and 2.5mm <sup>2</sup>

Data protection	
Type	EEPROM backup of all setting. Backup of running totals every minute. Data retention at least 10 years.
Pass code	Configuration settings can be pass code protected.

Hazardous area (option)	
Intrinsically safe Type XI	<p><b>ATEX approval:</b> II 1 G Ex ia IIC T4 II 1 D Ex iaD 20 IP 65 / 67 T 100°C</p> <p><b>IECEx approval:</b> Ga Ex ia IIC T4 Ex iaD 20 IP 65 / 67 T 100°C</p> <p><b>CSA / FM approval :</b> IS Class I/II/III, Division 1 Groups A to G T4 Class I zone 0 AEx ia IIC T4</p>
Explosion proof Type XF	ATEX approval ref.: <EX> II 2 GD EEx d IIB T5. Weight appr. 15kg. Dimensions of enclosure: 350 x 250 x 200mm (13.7" x 9.9" x 7.9") LxHxD.



<b>Environment</b>	
Electromagnetic compatibility	Compliant ref: EN 61326 (1997), EN 61010-1 (1993)
Low voltage directive	Compliant ref: EN60950.

## INPUTS

<b>Flowmeter</b>	
Type P	Coil/sine wave (minimum 20mVpp or 80mVpp - sensitivity selectable)
Frequency	Minimum 0 Hz - maximum 7 kHz for total and flowrate.
K-Factor	0.000010 - 9,999,999 with variable decimal position.
Note	For coil signal input: higher sensitivity is available - type ZF (10mVpp) / type ZG (5mVpp).

## OPERATIONAL

<b>Operator functions</b>	
Displayed functions	<ul style="list-style-type: none"> <li>total and/or flowrate.</li> <li>total and accumulated total.</li> <li>total can be reset to zero by pressing the CLEAR-key twice.</li> </ul>

<b>Total</b>	
Digits	7 digits.
Units	L, m3, GAL, USGAL, KG, lb, bbl, no unit.
Decimals	0 - 1 - 2 or 3.
Note	total can be reset to zero.

<b>Accumulated total</b>	
Digits	11 digits.
Units / decimals	according to selection for total.

<b>Flowrate</b>	
Digits	7 digits.
Units	mL, L, m3, Gallons, KG, Ton, lb, bl, cf, RND, ft3, scf, Nm3, NI, ical - no units.
Decimals	0 - 1 - 2 or 3.
Time units	/sec - /min - /hr - /day.

## APPENDIX B: PROBLEM SOLVING

In this appendix, several problems are included that can occur when the TUR0121-P is going to be installed or while it is in operation.

### Flowmeter does not generate pulses:

Check:

- Signal selection SETUP - 51,
- Pulse amplitude (par. 4.4.2. / 4.4.3.),
- Flowmeter, wiring and connection of terminal connectors (par. 4.4.2.2.),
- Power supply of flowmeter (par. 4.4.2.2.).

### Flowmeter generates "too many pulses":

Check:

- Settings for total and Flowrate: SETUP 11-14 and 21-27,
- Type of signal selected with actual signal generated - SETUP - 51,
- Sensitivity of coil input - SETUP - 51 and par. 4.4.2.2.
- Use screened wire for flowmeter signals and connect screen to the "⊥" terminal.

### Flowrate displays "0 / zero" while there is flow (total is counting):

Check:

- SETUP 22 / 25: are the K-factor and time unit correct?
- SETUP 26 / 27: The unit has to count the number of pulses according to SETUP 26 within the time according to SETUP 27. Make sure that 27 is set to 10.0 seconds for example : the result is that the unit has at least 10 seconds time to measure the number of pulses according to SETUP 26.

### The pass code is unknown:

If the pass code is not 1234, there is only one possibility left: call your supplier.

### ALARM

When the alarm flag starts to blink an internal alarm condition has occurred. Press the "select button" several times to display the 5-digit error code. The codes are:

- 0001: irrecoverable display-data error: data on the display might be corrupted.
- 0002: irrecoverable data-storage error: the programming cycle might have gone wrong: check programmed values.
- 0003: error 1 and error 2 occurred simultaneously

The alarm condition will almost certainly be handled internally and if all mentioned values still appear correct, no intervention by the operator is needed. If the alarm occurs more often or stays active for a longer time, please contact your supplier.

## INDEX OF THIS MANUAL

accumulated total	7	Intrinsic safety	18
	28	IP classification	16
backlight		keys	6
color	14	low-battery	7
density	14	main-function	9
battery life time	14, 23	maintenance	23
Battery replacement	22	manual version	3
clear total	7	model	15
coil-signal	20	operational	6
configuration	8	operator level	7
contents	4	pass code	15, 26
dimensions	17	power supply	20
display		power supply backlight	20
function	14	problem solving	26
display update time	14	rate / total	7
flowmeter		safety instructions	2
signal	15	serial number	15
flowmeter input	20	setup-level	8
flowrate		software version	3
calculation	13	subfunction	9
cut-off time	13	tagnumber	15
decimals	13	technical specification	24
decimals k-factor	13	terminal connectors	19
measuring unit	13	total	
time unit	13	decimals	12
functional description	5	decimals k-factor	12
hardware version	3	k-factor	12, 13
installation	16	measuring unit	12
intrinsic safety	18	version software	15

## LIST OF FIGURES IN THIS MANUAL

Fig. 1: Typical application for the TUR012-P. ....	5
Fig. 2: Control Panel.....	6
Fig. 3: Example of display information during process. ....	7
Fig. 4: Example of low-battery alarm.....	7
Fig. 5: Dimension enclosures.....	17
Fig. 6: Example serial number. ....	18
Fig. 7: Label information Intrinsically Safe application.....	19
Fig. 8: Overview of terminal connectors TUR0121-P-(PC / PX) and options. ....	19
Fig. 9: Configuration example Intrinsically Safe.....	21
Fig. 10: Configuration example Intrinsically Safe.....	21
Fig. 11: Battery replacement instructions Intrinsically Safe Battery.....	22

**LIST OF CONFIGURATION SETTINGS**

SETTING	DEFAULT	DATE :	DATE :
---------	---------	--------	--------

1 - TOTAL	Enter your settings here		
11 unit	L		
12 decimals	0000000		
13 K-factor	0000001		
14 decimals K-factor	0		

2 - FLOWRATE	Enter your settings here		
21 unit	L		
22 time unit	/min		
23 decimals	0000000		
24 K-factor	0000001		
25 decimals K-factor	0		
26 calculation / pulses	010		
27 cut-off time	30.0 sec.		

3 - DISPLAY	Enter your settings here		
31 function	total		
32 backlight	off		
33 brightness	5		

4 - POWER MANAGEMENT	Enter your settings here		
41 LCD-new	1 sec.		
42 mode	operational		

5 - FLOWMETER	Enter your settings here		
51 signal	coil-lo		

6 - OTHERS	Enter your settings here		
61 model	F0-P	F0-P	F0-P
62 type	TUR0121-P	TUR0121-P	TUR0121-P
63 software version	03.____.____	03.____.____	03.____.____
64 serial number	-----	-----	-----
65 pass code	0000		
66 tagnumber	0000000		